

THE PROPERTY OF THE DRAWING IS ESTABLISHED BY LAW. IT IS FORBIDDEN TO PRODUCE OR SHOW IT TO THIRD PART. WITHOUT A WRITTEN AGREEMENT.

Item	Name	Q.ty
1	CA.08.03.004	1
2	CA.08.09.004	1

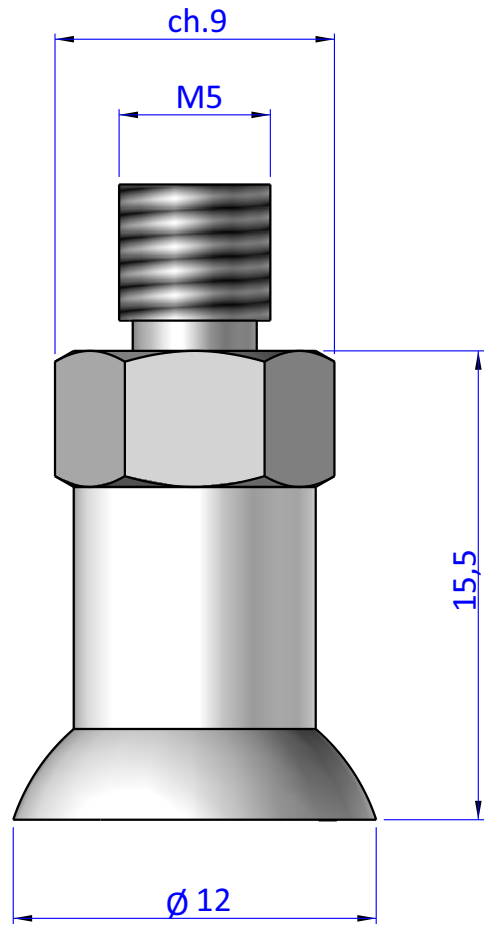
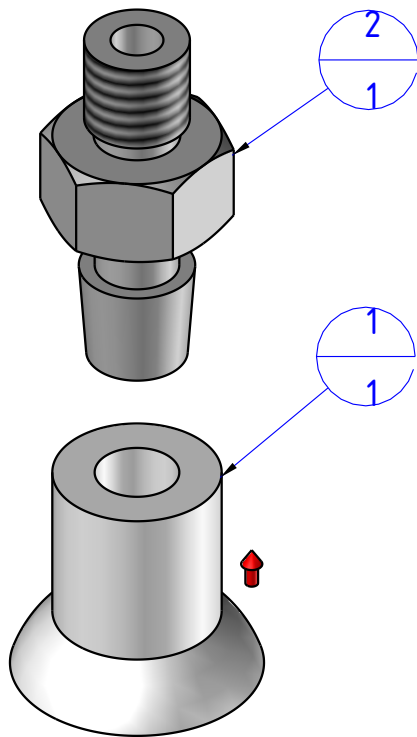

DESIGNED FROM	REVIEW
FPS Automation	A

DATE	WEIGHT
04/11/2020	0,002kg

CODE
KIT.08.03.D12.4

Format A4  
UNI 936-76

GENERAL TOLERANCE  
UNI - ISO 2768  
CLASSE f

DESCRIPTION  
KIT.08.03.D12.4